

6GHZ 1W 0DB QMA ATTENUATOR

R411.700.124

Series :
ATTENUATEUR

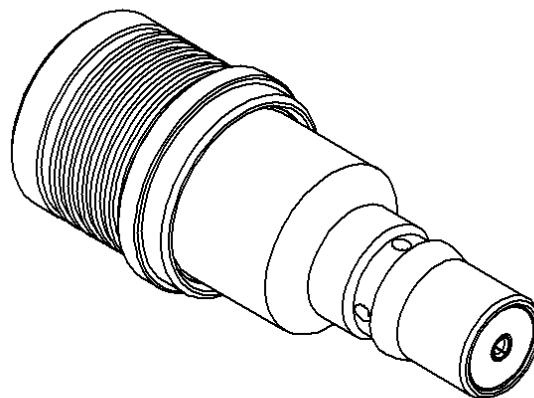
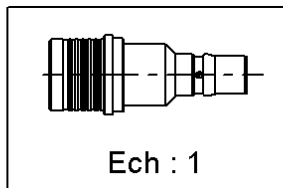
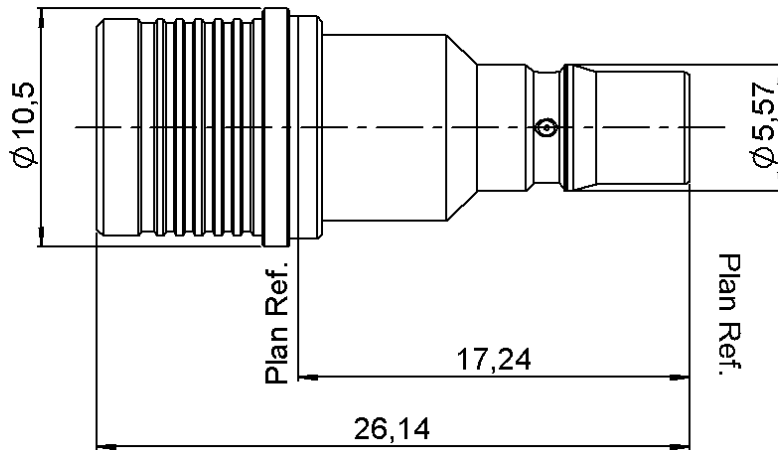

All dimensions are in mm.

COMPONENTS	MATERIALS	PLATING(μm)
BODY	BRASS	BBR 2
MALE CENTER CONTACT	BRASS	GOLD 1.3 OVER COPPER 2.5
FEMALE CENTER CONTACT	BERYLLIUM COPPER	GOLD 1.3 OVER COPPER 2.5
OUTER CONTACT	BRASS	BBR 2
INSULATOR	PTFE	
GASKET		
SUBSTRATE	ALUMINA	
RESISTOR	THICK FILM	
OTHERS PARTS		

Issue : 0805 C

In the effort to improve our products, we reserve the right to make changes judged to be necessary.



6GHZ 1W 0DB QMA ATTENUATOR

R411.700.124

Series :
ATTENUATEUR

ELECTRICAL CHARACTERISTICS

Frequency (GHz)	2	2 - 6
V.S.W.R (≤)	1.20	1.30
Deviation(±dB)	0.3	0.5

Operating Frequency Range		GHz
Impedance	50	Ω
Nominal Attenuation	0	dB
Peak power at 25°C (1μs, 1%)	100	W
Average power at 25°C	1	W (Free Air Cooled) W (Conduction Cooled)

MECHANICAL CHARACTERISTICS

Connectors	QMA
Weight	6,2600 g

ENVIRONMENTAL CHARACTERISTICS

Operating temperature range	-40 / +85 °C
Storage temperature range	-40 / +85 °C

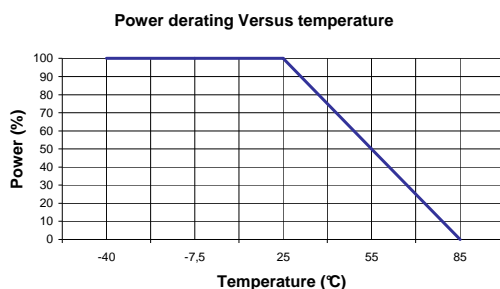

SPECIFICATION

OTHER CHARACTERISTICS

Issue : 0805 C

In the effort to improve our products, we reserve the right to make changes judged to be necessary.

